



INSTALLATION INSTRUCTIONS

Accessory
SKI ATTACHMENT
P/N 08L03-E09-200A

Application
2015 RDX

Publications No.
BII 51223
Issue Date
MARCH 2014

Put this information in the glove box with the vehicle owner's manual.

PARTS LIST

2 Ski attachments

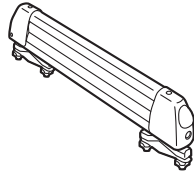

Wrench



2 Keys



8 Collars



4 Brackets

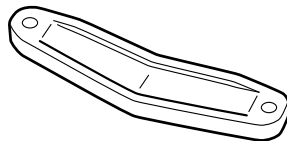

8 Bolts

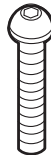
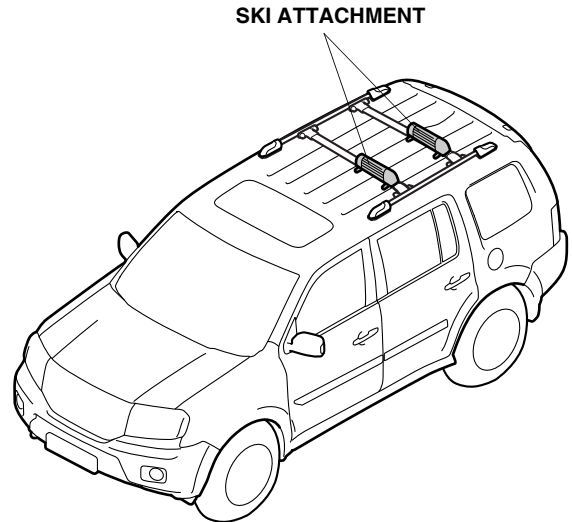

Illustration of the Ski Attachment on the Vehicle



INSTALLATION

Client Information: The information in this installation instruction is intended for use only by skilled technicians who have the proper tools, equipment, and training to correctly and safely add equipment to your vehicle. These procedures should not be attempted by "do-it-yourselfers."

NOTE:

- This ski attachment is designed to be used exclusively with the crossbars, which are sold separately.
- Do not use non-Acura accessories, carriers or attachment sets with this ski attachment kit.
- Install the ski attachment after installing the crossbars on the roof.
- Do not damage the roof and other finished surfaces of the body when installing the ski attachment.

Installing the Ski Attachment

1. Insert the key and turn it clockwise to unlock the ski attachment.

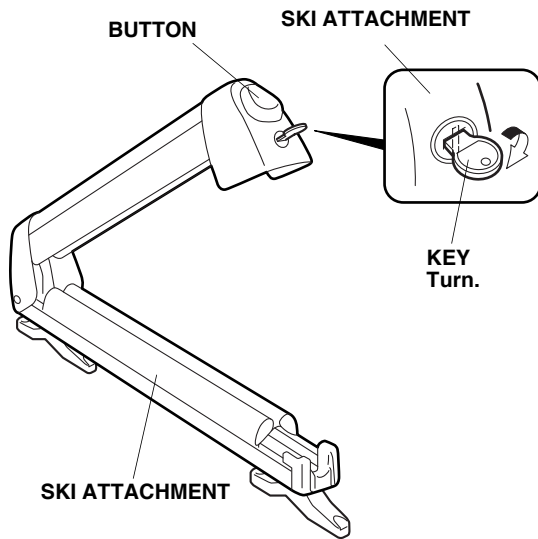

2. Push the button and raise the holder block on the ski attachment.
3. Turn the two brackets on the ski attachment as shown.

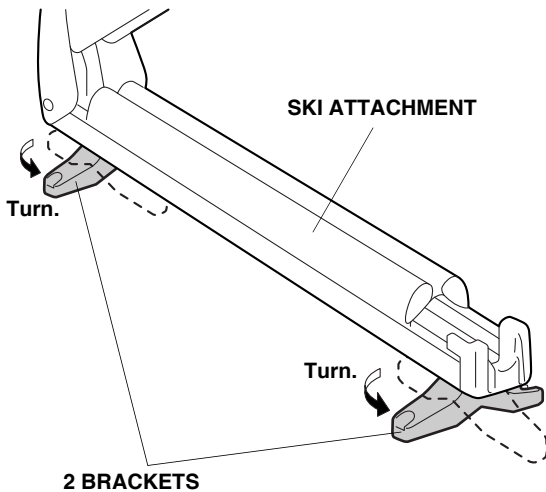

4. Using a wrench, install the ski attachment to the front crossbar with four bolts, four collars, and two brackets.

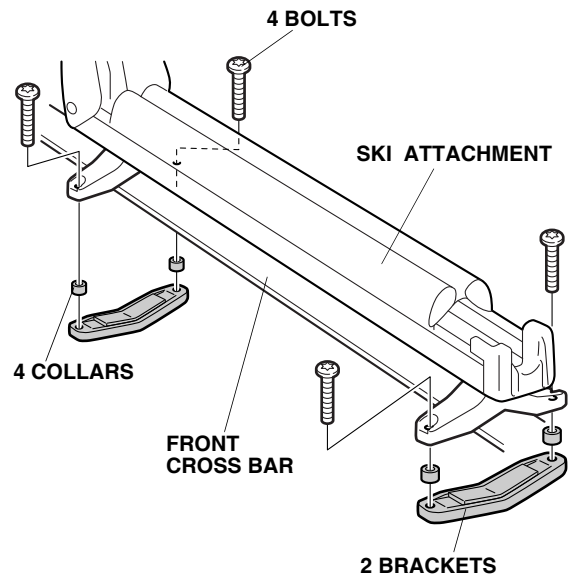

5. Repeat steps 1 through 4 to install the other ski attachment on the rear crossbar.
6. After installation, rock the ski attachment in all directions to make sure it is installed securely without play or rattles. If you find abnormal play or a rattle, retighten the bolts.

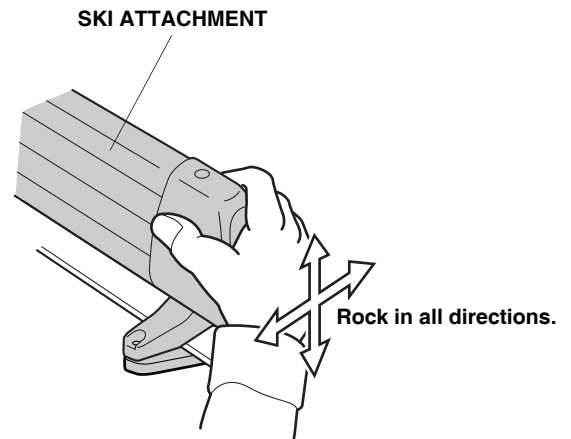

7. Write down the key number in the box below in case the key is lost or stolen.

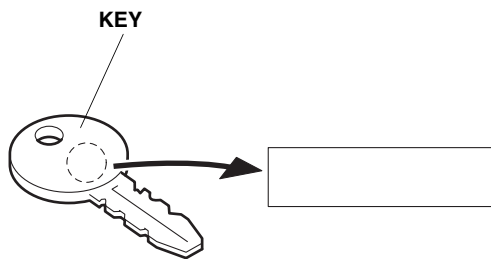

How to Load Skis on the Ski Attachment

8. Load the skis with the rear of the skis facing the front of the vehicle.

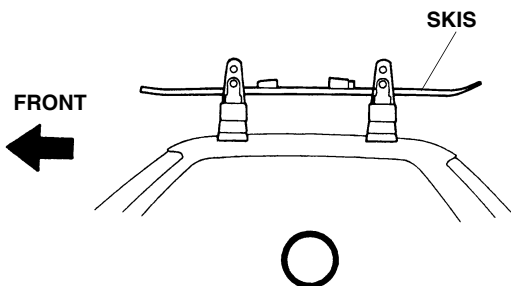

9. If the bindings cannot be positioned between the front and the rear attachments, install the skis with the rear bindings behind the rear attachment as shown.

ENOUGH SPAN

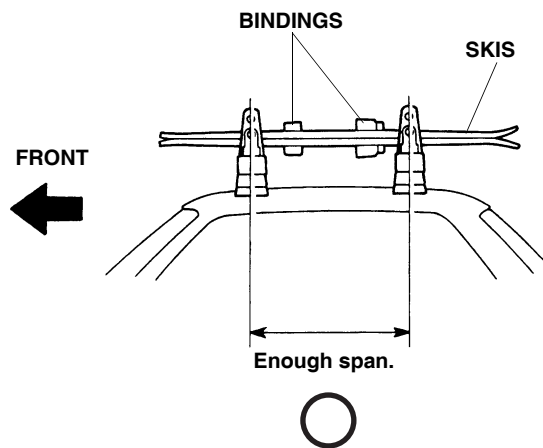

NOT ENOUGH SPAN

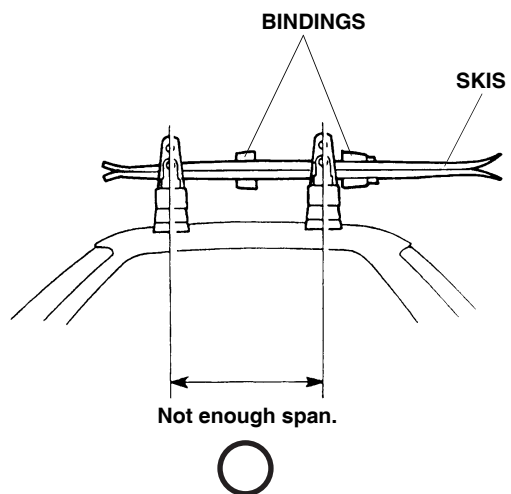

USE AND CARE

- Do not carry more than four pairs of skis on the attachment.
- The ski attachment raises the overall height of the vehicle. Pay attention to overhead obstacles when driving with the ski attachment.
- Before and after driving, or after loading skis on the attachment, check the security of the attachment mounts and retighten them as necessary.

PRECAUTION

- Avoid sudden starts or stops with the attachment on the vehicle. It may cause bolts and other fasteners to loosen.
- Obey local laws and regulations.
- Before driving, check that the attachment is locked securely regardless of whether or not skis are mounted on the attachment.
- Do not use the ski attachment with vehicles other than those specified.